

SIDE SECTION VIEW

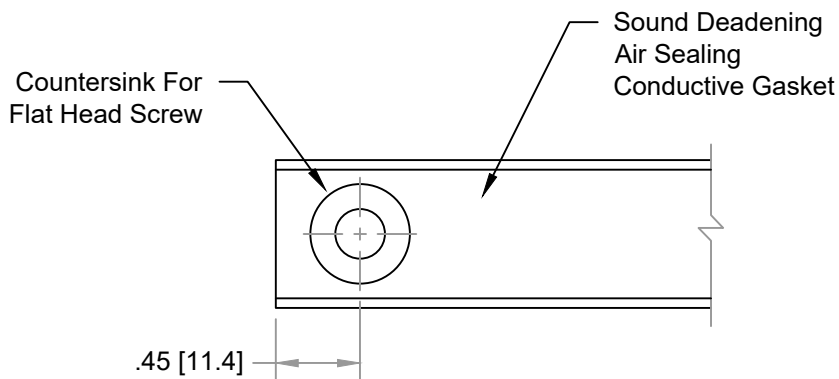

TOP END VIEW

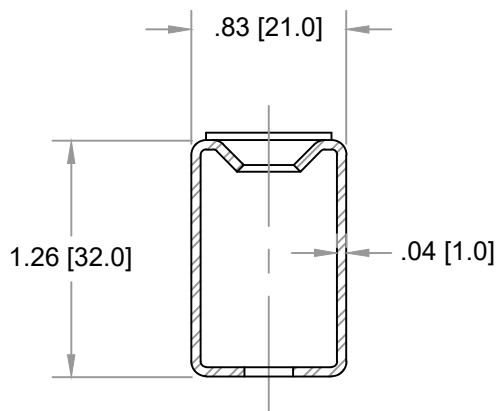

END SECTION VIEW

NOTE: Cut-Sheet drawing and specifications are subject to change without prior notice.



9500 Industrial Center Dr.
Ladson, SC, 29456
www.asmproducts.com

Tel: 843-534-1110
Fax: 843-534-1111

SSD-4
4' RIGID GRID STRINGER