

FS400 Enviro-Panel

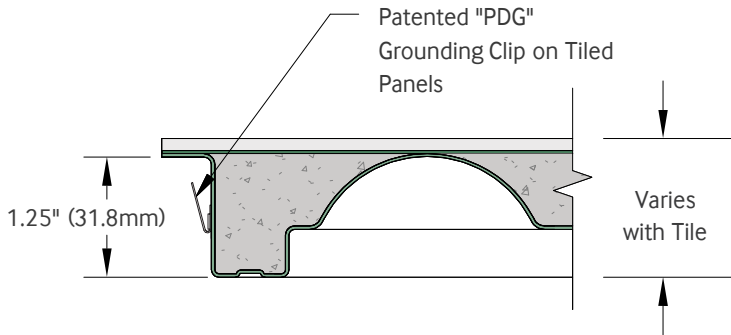

TILE COVERED PANEL

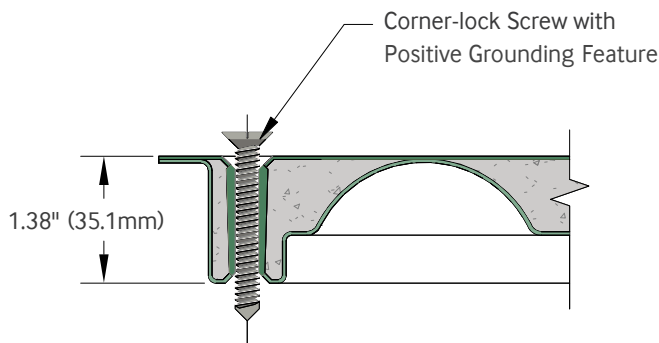

BARE CORNER-LOCK PANEL

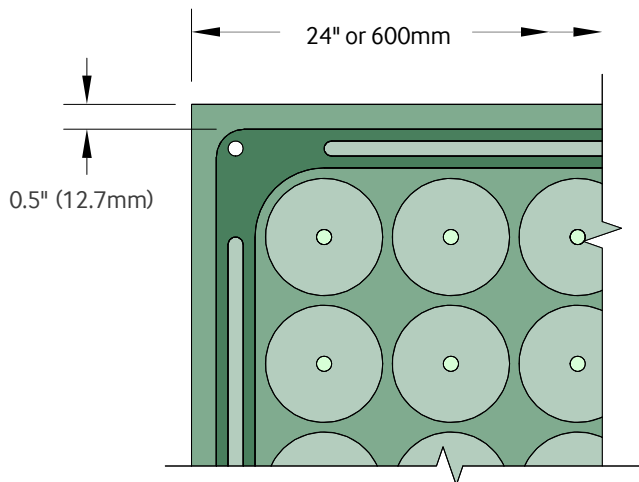

PARTIAL BOTTOM VIEW

PHYSICAL DATA

- Weight of Bare Panel: 42 lb. (19.1 kg)
- Height of Bare Panel: 1.38" (35.1 mm)
- Fire Rating of Bare Panel:
 - ASTM E84: Class A Flame Spread
 - EN13501-1: A2fl-S1
 - EN13501-2: REI 30-r

PERFORMANCE DATA

- Concentrated Load Rating: 2,000 lbs (8.9 kN)
- Uniform Load Rating: 800 psf (38.30kN/m²)
- Ultimate Load Rating: Min. 4,000 lbs (17.79kN)
 - Safety Factor: 2-to-1 Min.
- Impact Load Rating: 200 lb. (91Kg)
- Rolling Load Rating:
 - CISC Wheel A (10 Pass): 1,500 lbs (6.67 kN)
 - CISC Wheel B (10K Pass): 1,250 lbs (5.56 kN)

FINISH OPTIONS

- HPL Tile (1 / 16")
 - Integral Trim or Smart Trim
- Vinyl Tile:
 - VPT "Con-Tile" (Static Conductive)
 - VPT "Stat-Tile" (Static Dissipative)
- RubberTile:
 - Antistatic
 - Standard
- Bare Surface
- Bare Corner-Lock
- Contact ASM for other tile options such as Bamboo, Cork, Ceramic, Wood, Stone, etc.

UNDERSTRUCTURE OPTIONS

- Free Standing - Stringerless
- Corner-Lock
- Rigid Grid Bolted Stringers
 - 2' x 2' System or 600mm x 600mm System
 - 2' x 4' System or 600mm x 1200mm System
 - 4' x 4' or 1200mm x 1200mm Basketweave System

FEATURES

- Available in (24") or (600mm) Size
- Powder Coat Epoxy Paint Finish
- Welded Steel Construction (Recycled)
- Full-Hard Steel Top Sheet
- Full-Strength, Deep Drawn Corners
- Light Weight Cementitious Fill (Recycled)

(Date of Revision: 3/3/2026)