

**TILE COVERED PANEL**

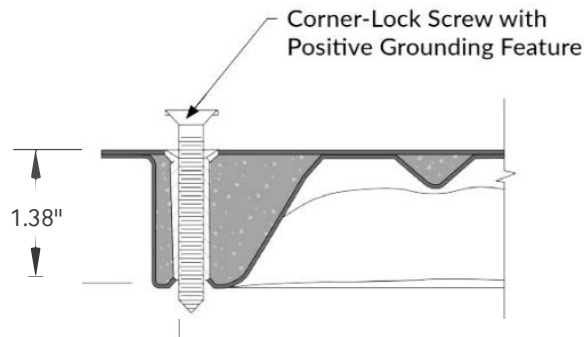

**BARE CORNER-LOCK PANEL**

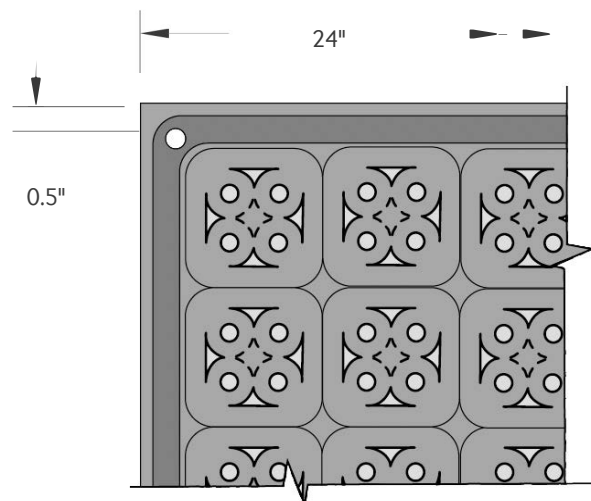

**PARTIAL BOTTOM VIEW**

### PHYSICAL DATA

- Weight of Bare Panel: 42 lb.
- Height of Bare Panel: 1.38"
- Fire Rating of Bare Panel:
  - ASTM E84: Class A Flame Spread
  - EN13501-1: A2fl-S1
  - EN13501-2: REI 30-r

### PERFORMANCE DATA

- Concentrated Load Rating: 2,000 lbs
- Uniform Load Rating: 800 psf
- Ultimate Load Rating: Min. 4,000 lbs
  - Safety Factor: 2-to-1 Min.
- Impact Load Rating: 200 lb.
- Rolling Load Rating:
  - Cisca Wheel A (10 Pass): 1,500 lbs
  - Cisca Wheel B (10K Pass): 1,250 lbs

### FINISH OPTIONS

- HPL Tile (1/16")
  - Integral Trim or Smart Trim
  - VPT "Con-Tile" (Static Conductive)
  - VPT "Stat-Tile" (Static Dissipative)
- RubberTile:
  - Antistatic
  - Standard
- Bare Surface
- Bare Corner-Lock
- Contact ASM for other tile options such as Bamboo, Cork, Ceramic, Wood, Stone, etc.

### UNDERSTRUCTURE OPTIONS

- Free Standing - Stringerless
- Corner-Lock
- Rigid Grid Bolted Stringers
  - 2' x 2' System
  - 2' x 4' System
  - 4' x 4' Basketweave System

### FEATURES

- Available in 24" Size
- Powder Coat Epoxy Paint Finish
- Welded Steel Construction (Recycled)
- Full-Hard Steel Top Sheet
- Full-Strength, Deep Drawn Corners
- Light Weight Cementitious Fill (Recycled)

(Date of Revision: 26/1/2026)